

BROEN-LAB EMERGENCY SHOWER SYSTEMS

BROEN-LAB EMERGENCY SHOWER SYSTEMS

BROEN-LAB EMERGENCY SHOWER SYSTEMS

NEW MODELS

- Hand Held
Eye Showers
& Accessories



reddot design award
winner 2013

- Heated Emergency Showers
& Eye Washes



**EMERGENCY
SHOWER SYSTEMS**

BROEN-LAB

TABLE OF CONTENTS

Table of Content / Product Overview	2
Introduction / Customer Statements	3

Emergency Showers & Eye Washes

Hand Held Eye Showers & Accessories	NEW 4-5
Eye Showers	6-7
Recessed Emergency Showers	8-9
Body Showers for Wall & Ceiling	10
Body & Eye Showers for Wall Mounting	11
Showers with Flexible Choice of Valve	11
Free Standing Body & Eye Showers	12
Accessories for Emergency Showers	13-14
Test Equipment for Emergency Showers / Eye Wash Bottles	15
Hand Held Eye Showers - <i>Classic Models</i>	16

Heated Emergency Showers & Eye Washes

Introduction	17
Heated Combination Showers	NEW 18
Heated Body Showers	NEW 19
Heated Eye Showers	NEW 20
Mobile & Portable Emergency Showers	NEW 20
Heated Tank Showers	NEW 21
Accessories for Heated Showers	NEW 22
General Information	23
International Standards	24-25
Technical Information	26
Notes	27

PRODUCT OVERVIEW

- Please refer to the actual page for product versions





Our extensive knowledge allows us to continually develop and optimize our products so that they meet our customer needs and specifications. Safety, functionality and quality are an integral part of product design and flexibility.

BROEN-LAB – A SAFE CHOICE

- Quality since 1948
- Complete product range
- Compliance with international standards
- Proven functionality world-wide
- Spare parts available for a guaranteed 10-year period

CUSTOMER STATEMENTS



Falck

IN THE SERVICE INDUSTRIES



"For more than four years Falck has had an excellent cooperation with BROEN-LAB. Our customers must be able to rely on Falck to guarantee the best solutions and consequently we only provide service for emergency showers that comply with the requirements of Danish Standard 15154 Parts I and II.

BROEN-LAB products are extremely easy to install and they are also clearly marked and easily serviced. Quite simply, they provide a better and safer solution for all parties."

Michael Hansen, Product Manager Falck



IN INDUSTRY



"At Carlsberg we do not accept a compromise with regard to quality. We have therefore replaced all our emergency shower systems by products from BROEN-LAB so that they comply with the EU norm EN 15154.

We want to look well after the people working for us and it is our distinct opinion that our workplace must be a place where you feel well and safe."

Jens Hansen, Coordinating Work Environment Representative Carlsberg Denmark



IN THE LABORATORY



"For quite some time our company has been in charge of the maintenance and service of installations at Akademiska Hus at Medicinberget in Gothenburg. This includes a number of laboratories which again means a considerable number of emergency shower systems supplied by BROEN-LAB.

We check the emergency showers regularly and are very content with BROEN-LAB's reliable design and construction which make them easy to inspect and test."

Anders Bergvall, Project Manager VVS-Teknik Mölndal



IN THE EDUCATIONAL SECTOR



"At DTU we teach more than 7,000 students within very different fields – from the metal industry to microbiology – and within each specific field unique safety aspects must be considered. Therefore it is essential for us that we have a cooperation partner who supplies a quality product and who can also advice and guide us on the specific risk profile of each classroom."

Bjarne Andersen, HVAC Manager at DTU Campus Service



IN THE MEDICAL INDUSTRY



"As an international advisor it is important for us to have a partner that complies with both national and international norms and standards – and who can document this by an independent third party certification. At the same time it is important to have a partner that can offer customized solutions supporting the architectonic expression of the project instead of colliding with it. Even though we are talking about emergency equipment, beautiful design is a plus."

Henrik Als Nielsen, Engineer, Ventilation & Building Utilities, NNE Pharmaplan

HAND-HELD EYE SHOWERS

BROEN-LAB has developed new hand-held eye showers, which comply to EN15154-2 and ANSI Z358.1 norms and also offer many improved features.

TECHNICAL SPECIFICATIONS

Min. working pressure: 1.5 bar
 Max. working pressure: 10 bar
 Min. temperature: 5°C
 Max. temperature: 80°C

MATERIALS WITH MEDIA CONTACT

Plastics: PA, POM, TPE
 Metals: SS, AISI 316
 Rubber: EPDM

Materials not in media contact:
 PP, PA, SEBS

SAFETY

- Improved trigger lock
- Improved activation of the shower

OPERATION

- Stay-open dust cap
- Light weight
- Well-balanced construction
- Better spray pattern

RELIABILITY

- Easy-to-clean spray head
- Anti-limescale design and material choice
- Improved functionality
- Longer lifetime

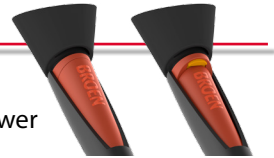

reddot design award
 winner 2013

BROEN-LAB EMERGENCY SHOWER SYSTEMS

Eye Shower with Two 45° Heads



No. 27 10 009 10 05 011

Weight: Approx. 0.5 kg

Table mounted eye shower with two 45° angled heads, incl. 1.5m inlet hose. Trigger operated including a built-in check valve and FLOWFIX for regulation of water flow (14 l/min).

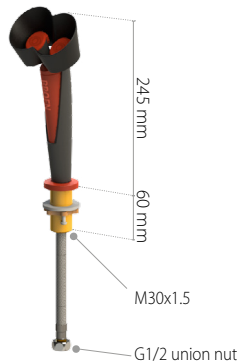

Eye Shower with Two 45° Heads



No. 27 10 009 10 03 011

Weight: Approx. 0.5 kg

Wall mounted eye shower with two 45° angled heads, incl. 1.5m inlet hose. Trigger operated including a built-in check valve and FLOWFIX for regulation of water flow (14 l/min).

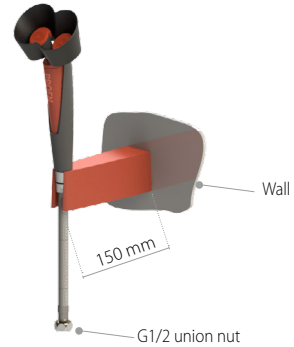

Eye Shower with a Single 45° Head



No. 27 10 003 10 05 011

Weight: Approx. 0.5 kg

Table mounted eye shower with a single 45° head, incl. 1.5m inlet hose. Trigger operated including a built-in check valve and FLOWFIX for regulation of water flow (7 l/min).

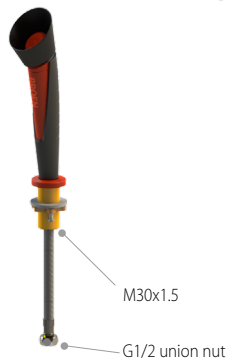

Eye Shower with a Single 45° Head



No. 27 10 003 10 03 011

Weight: Approx. 0.5 kg

Wall mounted eye shower with a single 45° head, incl. 1.5m inlet hose. Trigger operated including a built-in check valve and FLOWFIX for regulation of water flow (7 l/min).

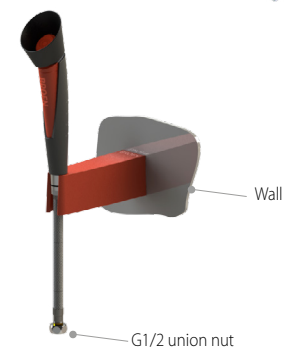

Other configurations are possible - please refer to ordering information on page 5.

HAND-HELD EYE SHOWERS - AVAILABLE MODELS

Shower for General Purpose Rinsing

No. 27 10 001 10 00 001

Weight: Approx. 0.1 kg

Shower for general purpose rinsing. Trigger operated including a built-in check valve. Without FLOWFIX for regulation.

Also available as straight model.



Eye Shower with a Single 45° Head

No. 27 10 003 10 00 001

Weight: Approx. 0.2 kg

Eye shower with a single head. Trigger operated including a built-in check valve and FLOWFIX for regulation of water flow (7 l/min).

Also available as straight model.



Eye Shower with Two 45° Heads

No. 27 10 009 10 00 001

Weight: Approx. 0.2 kg

Eye shower with two angled heads. Trigger operated including a built-in check valve and FLOWFIX for regulation of water flow (14 l/min).

Also available as straight model.



ACCESSORIES FOR HAND-HELD EYE SHOWERS

Mounting Accessories (YY):

No. 17 760.300

Table base (M30x1.5, 60mm)



No. 17 760.310

45° Wall base



No. 17 760.320

Wall bracket

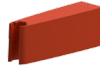

No. 17 760.330

Bracket for modular body shower

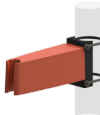

Signs and Instructions (YY):

No. 17 001.970

Complete set with signs and instructions for eye shower

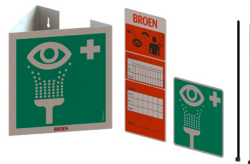

No. 96M0339

Sign for eye shower (sticker)



Hoses and hose accessories (ZZ):

No. 93H40431500

1.5m Silicone hose with a Stainless Steel braiding for hand-held eye showers.



Length 2m: No. 93H40432000

(other lengths on request).

No. 17 701.750

Counter weight/stop for hose

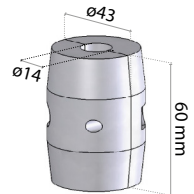

ORDERING INFORMATION

For ordering a complete hand-held eye shower including accessories, please follow the following structure:

27 10 XXX 10 YY ZZ 1

Serial number

- 001 - Rinsing model, 45°
- 003 - Eye Shower, single, 45°
- 004 - Rinsing model, straight
- 006 - Eye shower, single, straight
- 009 - Eye shower, double, 45°
- 012 - Eye shower, double, straight

Country code

- 10 - International

* Accessories

- 00 - None
- 01 - 17 001.970
- 02 - 96M0339
- 03 - 17 001.970 + Wall bracket
- 04 - 17 001.970 + 45° Wall Base
- 05 - 17 001.970 + Table base
- 06 - 96M0339 + Wall bracket
- 07 - 96M0339 + 45° Wall Base
- 08 - 96M0339 + Table base
- 09 - 96M0339 + Bracket for modular body shower

* Hose length + Hose accessory

- 00 - None
- 01 - 1.5m with G1/2 union nut
- 02 - 1.5m with G1/2 union nut + stop
- 03 - 2m with G1/2 union nut
- 04 - 2m with G1/2 union nut + stop

* Please request document No. 99G0045 for a complete list of available hoses and accessories.

For more information and technical datasheets please contact your BROEN-LAB sales representative.

EYE SHOWERS FOR WALL MOUNTING

The European Standard EN15154 advise that the water temperature delivered by emergency equipment should be "tepid".

Consequently, BROEN-LAB recommends the installation of a Thermostatic Mixing Valve (TMV) with safety shower equipment.

Please refer to page 13 for further information.



BROEN-LAB EMERGENCY SHOWER SYSTEMS

Eye Shower, Wall Mounted

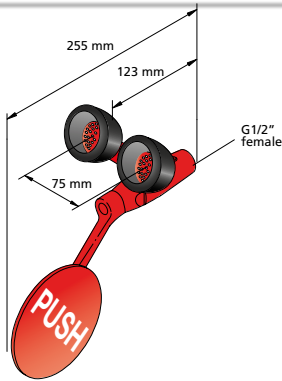

No. 17 067.009
WS: 765873 315

Other Models

No. 17 066.009
WS: 765871 315
With 1 shower head

Weight: Approx. 1 kg

Eye shower, wall mounted with two heads in brass with chemical resistant BROEN-LAB Polycoat and with built-in BALLOFIX® ball valve for regulation of water amount.

Min. working pressure 1.5 bar

Eye Shower, Wall Mounted

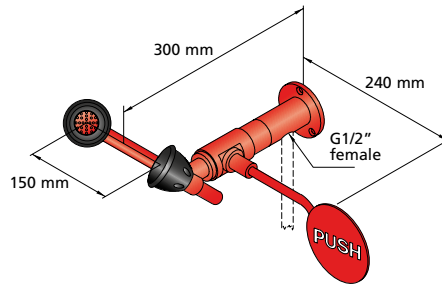

No. 17 069.009
WS: 765907 315

Other Models

No. 17 068.009
WS: 765904 315
Male inlet

Weight: Approx. 2 kg

Eye shower, wall mounted for exposed pipe work in brass with chemical resistant BROEN-LAB Polycoat with built-in FLOWFIX for water regulation (26 l/min).

Min. working pressure: 1.5 bar.

Eye/Face Shower with Bowl, Wall Mounted

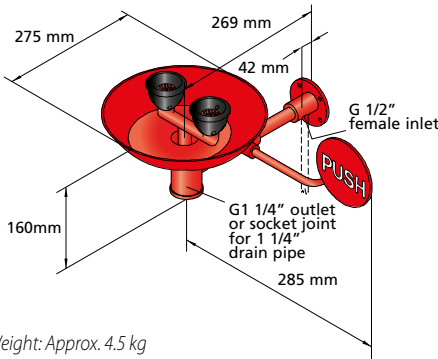

No. 17 928.009
WS: 765912 315

Other Models

No. 17 933.009
WS: 765912 345
Male inlet

Anti-corrosive
No. 17 928.004
G 1/2" female inlet

No. 17 933.004
Male inlet

Weight: Approx. 4.5 kg

Eye/Face shower with two heads in brass with chemical resistant BROEN-LAB Polycoat and Stainless Steel bowl. Wall mounted for exposed pipe work. The water amount is regulated by a built-in FLOWFIX (26 l/min).

Min. working pressure: 1.5 bar.

Eye Shower, Wall Mounted

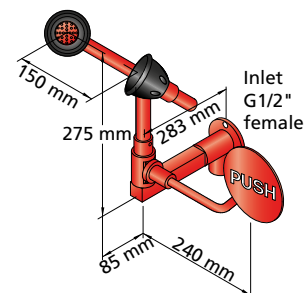

No. 17 250.009
WS: 765906 315

Weight: Approx. 4.5 kg

Eye shower, wall mounted in brass with chemical resistant BROEN-LAB Polycoat. The water is regulated with a built-in FLOWFIX (26 l/min).

Min. working pressure: 1.5 bar.

EYE SHOWERS FOR TABLE OR SWIVEL MOUNTING

Eye Shower, Table Mounted



No. 17 200.009
WS: 765905 315

Other Models

No. 17 202.009
WS: 765909 315
For exposed pipe work

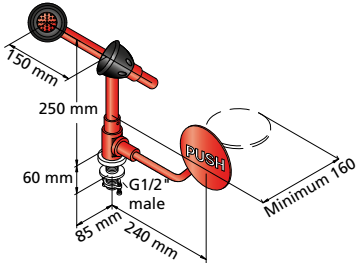

Weight: Approx. 2 kg

Eye shower, table mounted with two heads in brass with chemical resistant BROEN-LAB. Water is regulated with a built-in FLOWFIX (26 l/min).
Min. working pressure: 1.5 bar.

Eye Shower, Table Mounted, Swing Down



No. 17 927.009
WS: 765927 315

Other Models

No. 17 242.009
WS: 765928 315
For swivel wall mounting

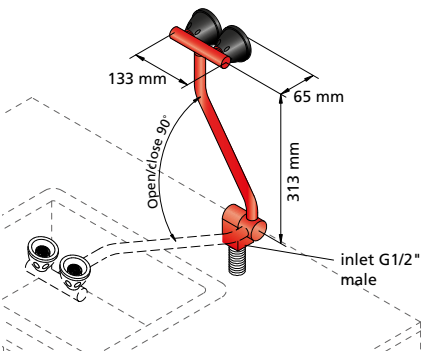

Weight: Approx. 4.5 kg

Eye shower, table mounted, swing down in brass with chemical resistant BROEN-LAB Polycoat for mounting on back side of the sink. The water amount is regulated with built-in FLOWFIX (26 l/min).
Min. working pressure: 2 bar.

Eye Shower, Table Mounted, Swivel Joint



No. 17 231.009
WS: 765926 315

Other Models

No. 17 230.009
WS: 765925 315
For mounting to the left of sink

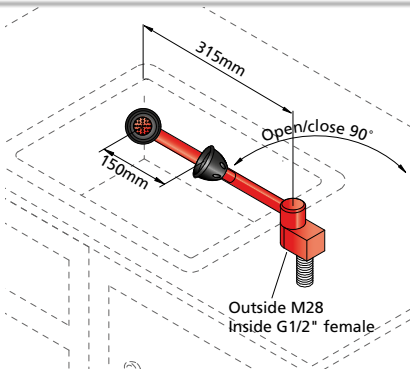

Weight: Approx. 4 kg

Eye shower, table mounted, swivel joint in brass with chemical resistant BROEN-LAB Polycoat for mounting on the right side of sink. The water amount is regulated with the built-in FLOWFIX (26 l/min).
Min. working pressure: 1.5 bar.



BROEN-LAB EMERGENCY SHOWER SYSTEMS

Eye/Face Shower with Bowl, Recessed



No. 17 934.009

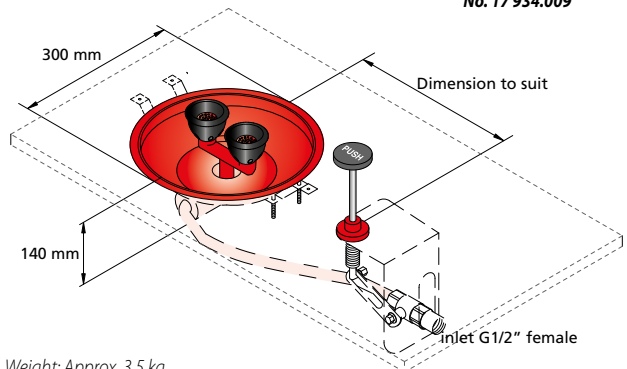

Weight: Approx. 3.5 kg

Eye/face shower with two heads in brass with chemical resistant BROEN-LAB Polycoat and Stainless Steel bowl for recessed mounting on table top, with push-down control. The water amount is regulated with built-in FLOWFIX (26 l/min).
Min. working pressure: 1.5 bar.

RECESSED EMERGENCY SHOWERS

SPECIAL FEATURES

GENERAL:

- Choose BROEN-LAB Polycoated surface or Stainless Steel.
- Cabinet and cabinet door in Stainless Steel AISI 304.
- Disability-Friendly models comply with ANSI A117.1-2003.
- Easy to mount and install.
- Cabinet can also be surface mounted (except 17 155.009).

Choose among different body shower outlets by ordering recessed units and outlets separately to fit your exact needs of installation and application.

E.g. : 17 154.009 + 17 110.009

BODY SHOWER:

- Strong integrated handle for operating body shower.
- Free choice of combination between ceiling or wall mounted body shower outlet.
- Easy to mount and install.
- Premounted valve for body shower.

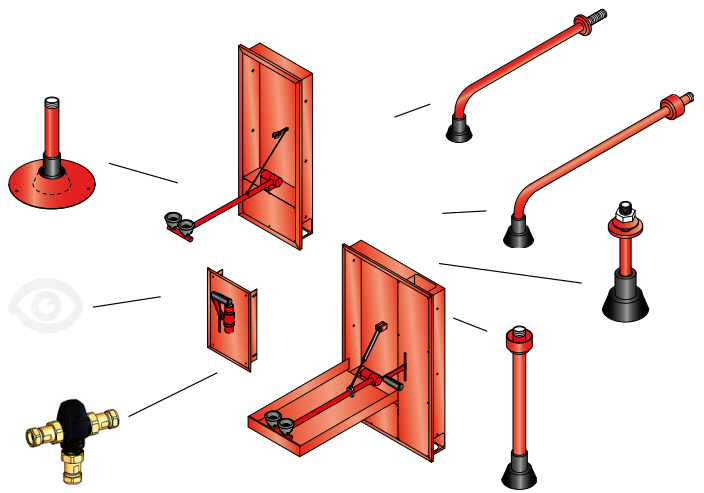

EYE WASH:

- Cabinet and cabinet door in Stainless Steel AISI 304.
- Integrated drain (on models with door).
- Cabinet door catches the water and prevents it from splashing on the floor.
- Filter BALLOFIX® ensures clean shower heads.

BROEN-LAB EMERGENCY SHOWER SYSTEMS

Body Shower Outlet, Ceiling Mounted, Concealed

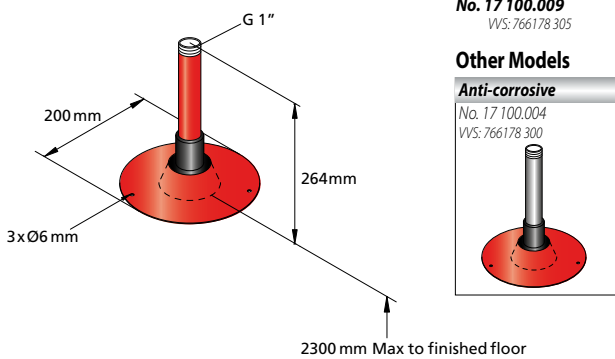

Weight: Approx. 1 kg

Body shower outlet, ceiling mounted, concealed in Stainless Steel with self-draining shower head. Inlet G 1" male.
Min. working pressure: 1.5 bar.

Body Shower Outlet, Ceiling Mounted

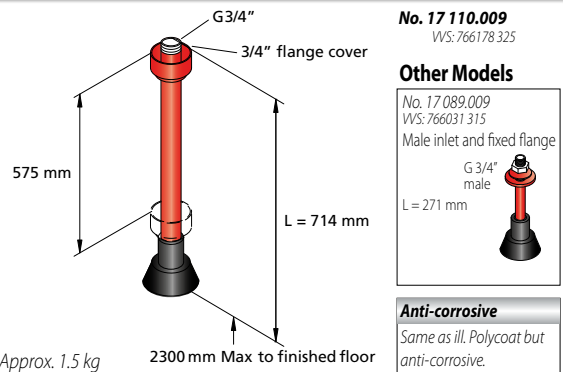

Weight: Approx. 1.5 kg

Body shower outlet, ceiling mounted, in brass with chemical resistant BROEN-LAB Polycoat with self-draining shower head. Fits different ceiling heights by adjusting the flange. Inlet G 3/4" male.
Min. working pressure: 1.5 bar.

Body Shower Outlet, Wall Mounted

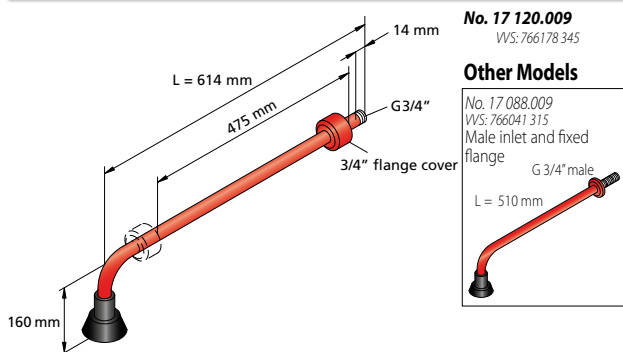

Weight: Approx. 1.5 kg

Body shower outlet, wall mounted, in brass with chemical resistant BROEN-LAB Polycoat with self-draining shower head. Inlet G 3/4" male.
With adjustable flange.
Min. working pressure: 1.5 bar.

Body Shower Outlet, Wall Mounted

Anti-corrosive



Disability-Friendly

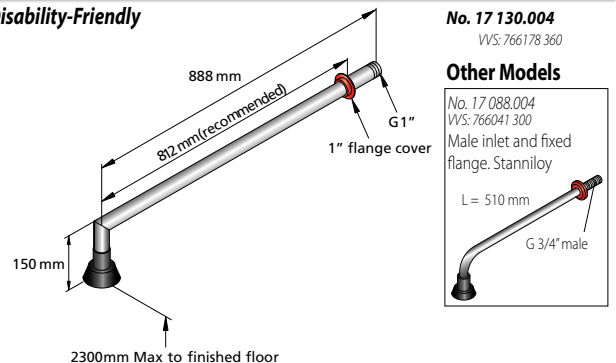

Weight: Approx. 1.5 kg

Wall mounted body shower outlet in Stainless Steel AISI 304, with self-draining shower head. Inlet G 1" male. With adjustable flange.
Dimensions comply with the requirements of ANSI A117.1-2003.
Min. working pressure: 1.5 bar.

RECESSED EMERGENCY SHOWERS

Eye Shower, Wall Recessed



No. 17 150.009
WS: 766156.305

Other Models

Anti-corrosive

Same as ill. Polycoat but anti-corrosive cabinet.
No. 17 160.009
WS: 766156.300

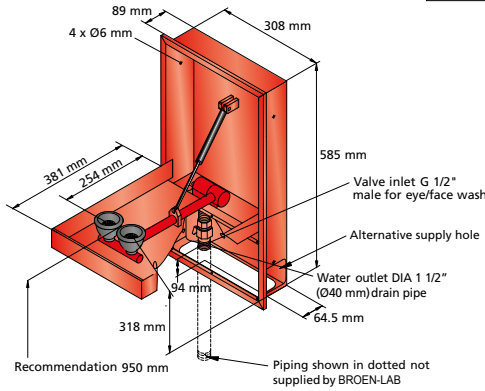

Weight: Approx. 8 kg

Eye shower, wall recessed with cabinet with chemical resistant BROEN-LAB Polycoat, two outlet heads and built-in FLOWFIX (14 l/min). Cabinet door activates the eye wash and catches the water. Min. working pressure: 2 bar.

Eye Shower, Wall Recessed



No. 17 152.009
WS: 766157.325

Disability-Friendly

Other Models

No. 17 151.009
WS: 766157.305
Without cabinet door.

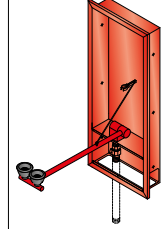

Anti-corrosive

Same as ill. Polycoat but anti-corrosive cabinet.
No. 17 162.009
WS: 766157.320

Without cabinet door
No. 17 161.009
WS: 766157.300



Weight: Approx. 10 kg

Eye shower, wall recessed, disability-friendly with cabinet with chemical resistant BROEN-LAB Polycoat, two outlet heads and built-in FLOWFIX (14 l/min). Cabinet door activates the eye wash and catches the water. Min. working pressure: 2 bar.

Eye and Body Shower, Wall Recessed



Disability-Friendly

No. 17 154.009
WS: 766177.325

Other Models

No. 17 153.009
WS: 766177.305
Without cabinet door

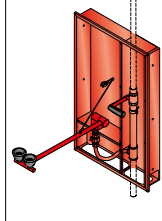

Anti-corrosive

Same as ill. Polycoat but anti-corrosive cabinet.
No. 17 164.009
WS: 766177.320

Without cabinet door
No. 17 163.009
WS: 766177.300

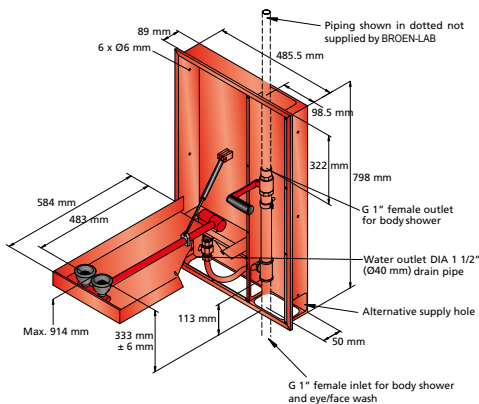

Weight: Approx. 16 kg

Eye shower, with 1" valve for body shower, wall recessed, disability-friendly with cabinet with chemical resistant BROEN-LAB Polycoat, two outlet heads and built-in FLOWFIX (14 l/min). Cabinet door activates the eye wash and catches the water. Integrated hand activating 1" valve for body shower with various options for shower outlet. Min. working pressure: 2 bar.

Body Shower, Wall Recessed, Hand Activator



No. 17 155.009
WS: 766176.305

Other Models

Anti-corrosive

Same as ill. Polycoat but anti-corrosive cabinet.
No. 17 165.009
WS: 766176.300

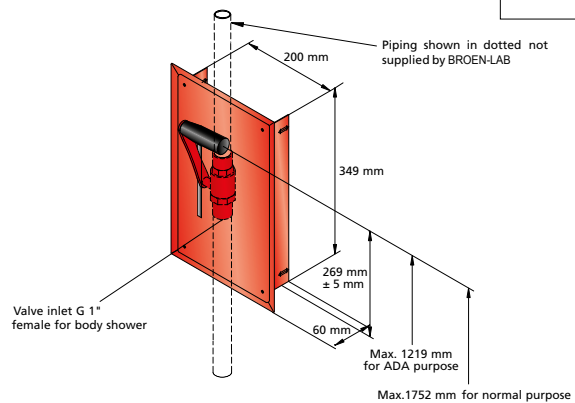

Weight: Approx. 2.5 kg

Wall recessed cabinet with chemical resistant BROEN-LAB Polycoat and hand activator for body shower with various options for shower outlet. 1" valve for 3/4" or 1" pipe. Min. working pressure: 1 bar.

BODY SHOWERS FOR WALL & CEILING

Body Shower, Ceiling Mounted

Anti-corrosive

No. 17 080.009
WS: 765964.315

Weight:
Approx. 2 kg

Body shower, ceiling mounted with self-draining head. In brass with chemical resistant BROEN-LAB Polycoat.

Min. working pressure: 1 bar.

No. 17 976.004

Weight:
Approx. 2.5 kg

Body Shower, ceiling mounted with self-draining head and adjustable flange. In Stainless Steel and Stanniloy.

Min. working pressure: 1 bar.

Body Shower, Wall Mounted

No. 17 973.009

Weight: Approx. 5.5 kg

Body shower, wall mounted with self-draining shower head. In brass with chemical resistant BROEN-LAB Polycoat.

Min. working pressure: 1 bar.

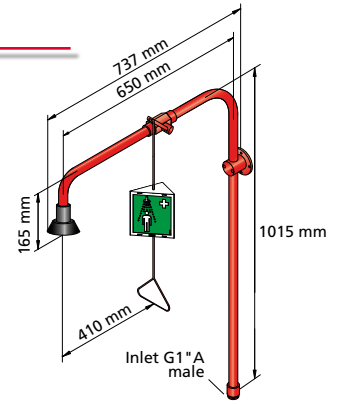

Body Shower, Wall Mounted

Anti-corrosive - Modular

No. 17 081.009
WS: 765974.315

Weight: Approx. 3 kg

Body shower, wall mounted with self-draining shower head. In brass with chemical resistant BROEN-LAB Polycoat.

Min. working pressure: 1 bar.

Supporting wall flange can be used for mounting (see page 13)

No. 17 970.004
WS: 766162.300

Weight: 4 kg

Body shower, wall mounted, modular in SS & Stanniloy with self-draining shower head for flexible wall mounting with pull rod.

Min. working pressure: 1 bar.

Other Models

No. 17 969.004
WS: 766161.300

Male inlet & flange cover
L = 774 mm

BROEN-LAB EMERGENCY SHOWER SYSTEMS

Body Shower for Exposed Pipework, Wall Mounted

Concealed Pipework



Anti-corrosive - Modular

No. 17 082.009
WS: 765984.315

Weight: Approx. 3 kg

Body shower for exposed pipework with self-draining head. In brass with chemical resistant BROEN-LAB Polycoat.

Min. working pressure: 1 bar.

Supporting wall flange can be used for mounting (see page 13)

No. 17 971.004
WS: 766163.300

Weight: 2.5 kg

Body shower, concealed, modular in SS with self-draining shower head for recessed flexible wall mounting. With extended pull rod for disabled people.

Min. working pressure: 1 bar.

Body Shower, Wall Mounted above Door

Anti-corrosive - Modular

No. 17 087.009
WS: 765992.315

Weight: Approx. 4.5 kg

Body shower, wall mounted above door for exposed pipework with self-draining head. In brass with chemical resistant BROEN-LAB Polycoat. Valve to be mounted left or right of door.

Min. working pressure: 1 bar.

No. 17 972.004
WS: 766162.340

Weight: Approx. 6.5 kg

Body shower, wall mounted above door for exposed pipework with self-draining head. In Stainless Steel and Stanniloy. Valve to be mounted left or right of door.

Min. working pressure: 1 bar.

BODY & EYE SHOWERS FOR WALL MOUNTING

Body and Eye Shower, Wall Mounted

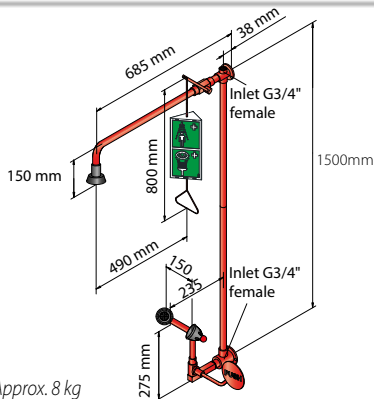

Weight: Approx. 8 kg

Body and eye shower, wall mounted in brass with chemical resistant BROEN-LAB Polycoat with self-draining shower head. Water inlet at the top or bottom. Eye shower has built-in FLOWFIX (26 l/min). Min. working pressure: 1.5 bar.

No. 17 455.009
VVS: 766000 315

Other Models



Body and Eye Shower, Wall Mounted, Modular

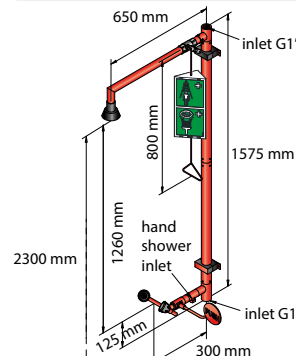

Weight: Approx. 11 kg

Body and eye shower, wall mounted, modular. In brass and SS with chemical resistant red BROEN-LAB Polycoat. Body shower has self-draining shower head. Water inlet at the top or bottom. Eye shower has built-in FLOWFIX (26 l/min). Min. working pressure: 1.5 bar.

No. 17 952.009
VVS: 766165 305

Other Models

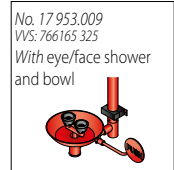

Anti-corrosive

Same as ill. Polycoat but anti-corrosive.
No. 17 963.004
VVS: 766165 300

With eye/face shower and bowl
No. 17 964.004
VVS: 766165 320

Body Shower, Wall mounted, Modular

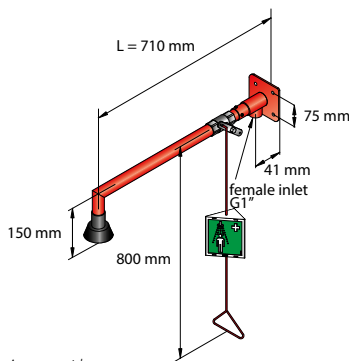

Weight: Approx. 4 kg

Body shower, wall mounted, modular. In brass and SS with chemical resistant red BROEN-LAB Polycoat with self-draining shower head for flexible wall mounting with pull rod. Min. working pressure: 1 bar.

No. 17 959.009
VVS: 766162 305

Other Models

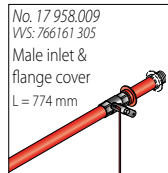

Body Shower, Concealed, Modular



Disability-Friendly

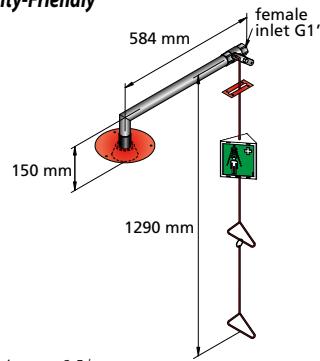

Weight: Approx. 2.5 kg

Body shower, concealed, modular. In SS and Chrome/Nickel plated brass with chemical resistant red BROEN-LAB Polycoat and self-draining shower head. For recessed flexible wall mounting. With extended pull rod for disabled people. Min. working pressure: 1 bar.

No. 17 960.009
VVS: 766163 305

SHOWERS WITH FLEXIBLE CHOICE OF VALVE

Body Shower Outlet for Flexible Choice of Valve

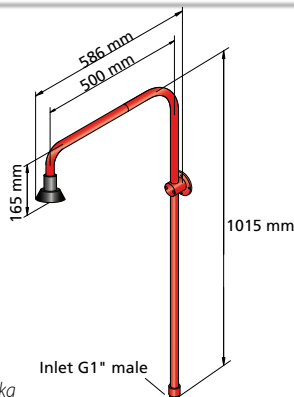

Weight: Approx. 4 kg

Body shower outlet for flexible choice of valve in brass and chemical resistant BROEN-LAB Polycoat. Min. working pressure: 1 bar.

No. 17 974.009

BALLOFIX® ball valve

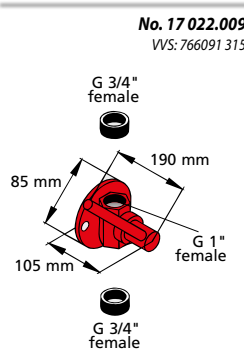

Weight: Approx. 1 kg

Manually hand operated of 1" BALLOFIX® ball valve for 3/4" pipe work.

No. 17 022.009
VVS: 766091 315

BALLOFIX® ball valve w./rod

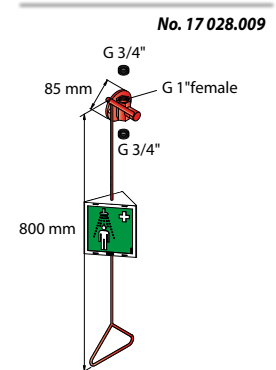

Weight: Approx. 1 kg

Manually rod operated 1" BALLOFIX® ball valve for 3/4" pipe work.

No. 17 028.009

Please refer to page 8 for more outlets for flexible choice of valve.

FREE STANDING BODY & EYE SHOWERS

BROEN-LAB EMERGENCY SHOWER SYSTEMS

Body Shower with Eye/Face Shower and Bowl, Modular

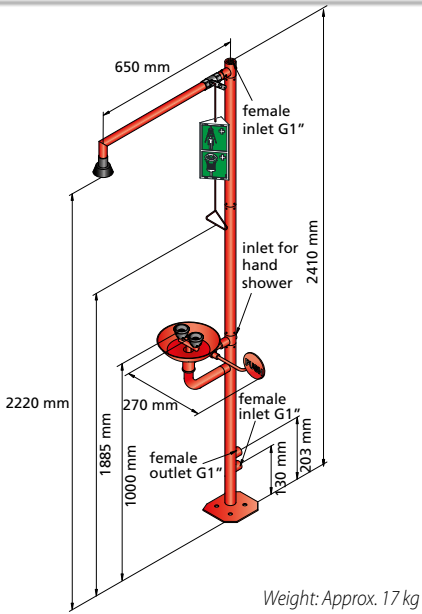

No. 17 956.009
VVS: 766171 345

Other Models

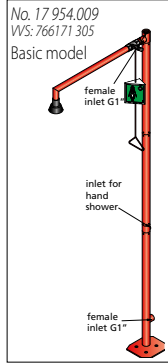
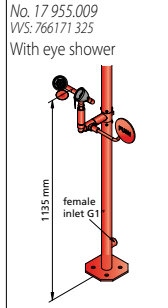

Weight: Approx. 17 kg

Body shower with eye/face shower and bowl, modular. In brass and SS with chemical resistant red BROEN-LAB Polycoat with self-draining shower head. Eye wash with built-in FLOWFIX for regulation of water flow (26 l/min). Bowl in Stainless Steel with integrated outlet. Min. working pressure: 1.5 bar.

Body Shower with Eye/Face Shower and Bowl, Modular



Disability-Friendly

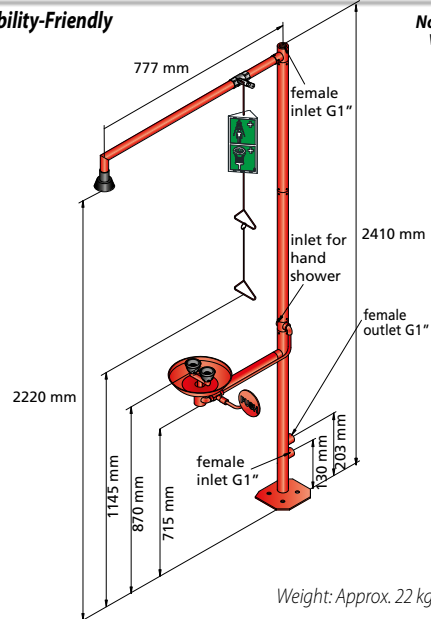

No. 17 957.009
VVS: 766172 305

Weight: Approx. 22 kg

Body shower with eye/face shower and bowl, modular. In brass and SS with chemical resistant red BROEN-LAB Polycoat with self-draining shower head. Eye wash with built-in FLOW-FIX for regulation of water flow (26 l/min). Bowl in Stainless Steel with integrated outlet. Min. working pressure: 1.5 bar.

Anti-corrosive - Modular

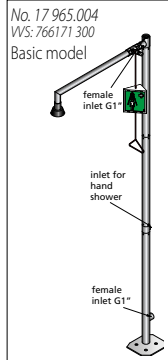
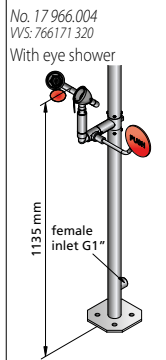
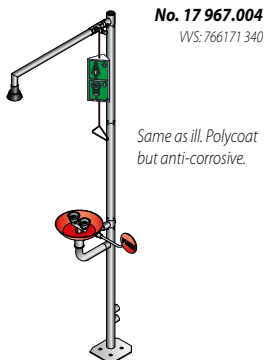

Anti-corrosive - Modular

Disability-Friendly

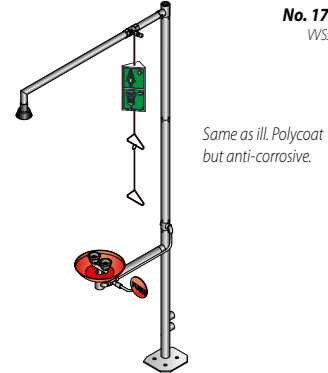

No. 17 968.004
VVS: 766172 300

Eye Shower, Free Standing, Modular



Anti-corrosive - Modular

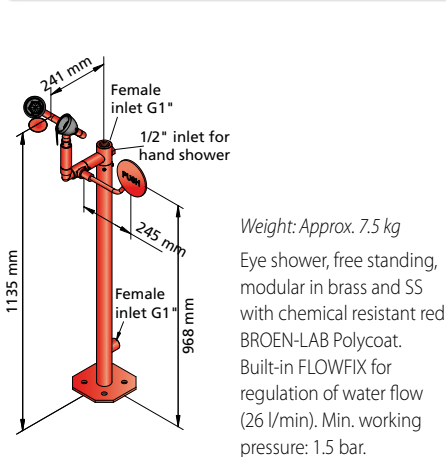

No. 17 950.009
VVS: 766152 305

Other Models

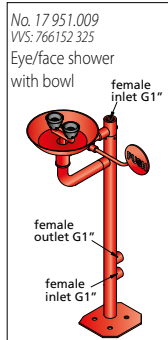

Weight: Approx. 7.5 kg
Eye shower, free standing, modular in brass and SS with chemical resistant red BROEN-LAB Polycoat. Built-in FLOWFIX for regulation of water flow (26 l/min). Min. working pressure: 1.5 bar.

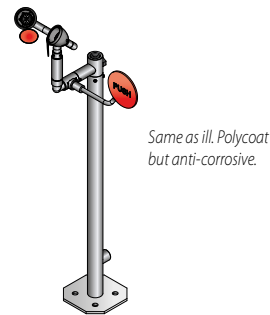

No. 17 961.004
VVS: 766152 300

Other Models

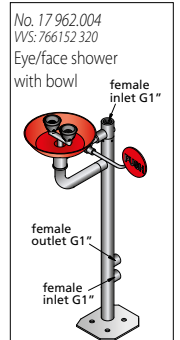

ACCESSORIES FOR EMERGENCY SHOWERS

Thermostatic Mixing Valves for Eye and Body Showers

BROEN-LAB TMVs for eye and body showers are thermostatic mixing valves designed for delivering tepid water (20-25°C) for eye/hand or body showers.

The solution is designed for the operation of one eye/hand shower respectively one body shower.

The mixed temperature is adjusted to tepid water from factory but can easily be adjusted on site by installer or operator.

The TMV incorporates in one body the following features:

- Fail-safe on hot side: If the cold water is interrupted the built-in anti-scalding device will automatically cease the flow of hot water. **AUTOMATIC OPERATION**
- Fail-safe on cold side: If the hot water is interrupted the built-in intentional leak will allow cold water to flow at a sufficient flowrate to ensure operation. **THIS WORKS AUTOMATICALLY AS WELL**
- Including check valves on both hot and cold supply

Thermostatic Mixing Valves for Eye Shower

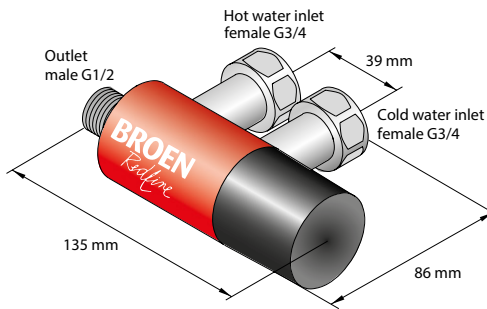

Weight: Approx. 1.5 kg

No. 17 140.009: (VVS: 766095 315)

Thermostatic mixing valve for eye shower.

Min. working pressure: 1 bar.

No. 26 140.059:

Lockable cap for 17 140.009.

Thermostatic Mixing Valves for Body Shower

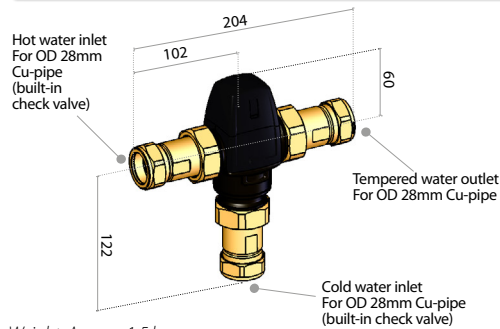

Weight: Approx. 1.5 kg

No. 17 459.009*: (VVS: 766094 315)

Thermostatic mixing valve for body shower.

Min. working pressure: 1.5 bar.

No. 17 460.009*: Model with G1" inlet/outlet connections

***Please note: Reduced temperature stability at low flow rates!**

Signs for Eye and Body Showers

Nr. 17 001.920

(Weight: Approx. 0.23 kg)

Sign (pull rod mounted) and instruction card for Body and Eye Shower



Nr. 17 002.27

(Weight: Approx. 0.03 kg)

Instruction and Service Sign - Body Shower



Nr. 96M0042

(Weight: Approx. 0.01 kg)

Sign for body shower (sticker)



Nr. 17 001.910

(Weight: Approx. 0.13 kg)

Sign (pull rod mounted) and instruction card for Body Shower



Nr. 17 002.28

(Weight: Approx. 0.03 kg)

Instruction and Service Sign - Body and Eye Shower



Nr. 96M0043

(Weight: Approx. 0.01 kg)

Sign for eye shower (sticker)



Nr. 17 002.010

(Weight: Approx. 0.15 kg)

Sign (wall mounted) and instruction card for Body and Eye Shower



Nr. 17 002.29

(Weight: Approx. 0.03 kg)

Instruction and Service Sign - Eye Shower fountain



Nr. 17 001.900

(Weight: Approx. 0.08 kg)

Sign (wall mounted) and instruction card for Eye Shower



Nr. 17 002.30

(Weight: Approx. 0.03 kg)

Instruction and Service Sign - Eye Shower - Hand-Held



Nr. 17 002.000

(Weight: Approx. 0.08 kg)

Sign (wall mounted) and instruction card for Body Shower



Nr. 17 002.31

(Weight: Approx. 0.03 kg)

Instruction and Service Sign - Body Shower with Hand-Held Eye Shower



Wall bracket for body showers

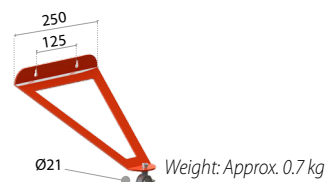

No. 17 001.079

Wall bracket for support of wall mounted body showers (size 1/2"). Other sizes on request

Cable

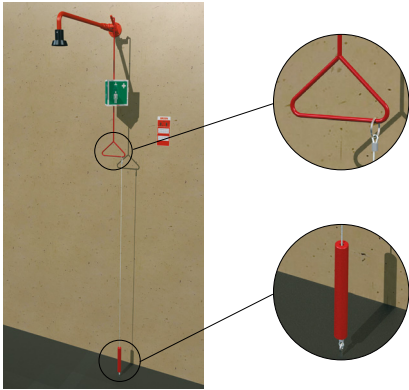

No. 17 901.64

A cable may be installed as a supplement to the pull rod solution i.e. the cable enables the user to activate the shower at floor level.

Foot Panel for Operation of Free Standing Body Shower

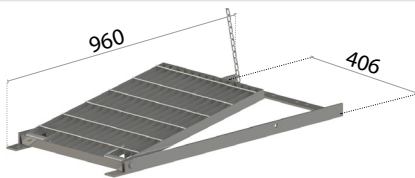

Weight: Approx. 23 kg

No. 17 919.009 (VVS: 766179 300) - *Stainless Steel*
No. 17 834.009 - *Galvanized Steel*

Foot panel for operation of body showers. Possible to combine with 17 909.909 if mounted 180° opposite. Delivered with all mounting accessories

Alarm for Emergency Shower



No. 17 851.95

Signal and light alarm for emergency showers.
 - 112dB(A) output
 - IP66 protection
 - 32 alarm tones
 Working temperature: -20°C to 70°C
 Power supply: 230VAC, 50/60Hz

For operation in Non Ex Proof areas.

Flow switch



Weight: Approx. 0,5 kg

Item no.	Material	Size*	PN, bar
96P0062	brass	G3/4	25
96P0063	brass	G 1 1/4	25
96P0066	SS	G3/4	25
96P0068	SS	G 1 1/4	25

* Please note that size of the flow switch should be a size bigger than the inlet of the emergency shower

- Good reliability
- Low pressure loss
- Dirt resistant
- Hermetic separation of electrical and hydraulic components
- Stress free fixation of switch unit by plastic cap

When there is a stream of water in the connection piping to the emergency shower the paddle in the flow switch is triggering an electrical reed switch. This switch can be connected to any type of warning system, such as an alarm central, a horn, a light or similar.

Foot Treadle for Operation of Eye Showers

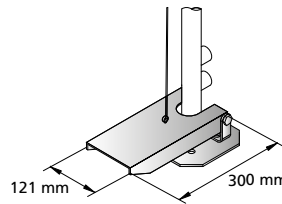

Weight: Approx. 1 kg

No. 17 909.909 (VVS: 766771 310)

Foot treadle in aluminium and SS for operation of eye showers. Possible to combine with 17 919.009 if mounted 180° opposite. Delivered with all mounting accessories.

Inlet hoses for Emergency Showers

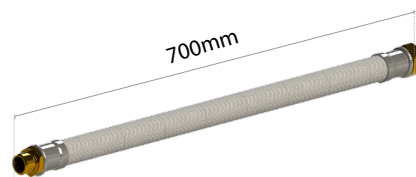

No. 17 701.72 (Male ISO 7/1-R1" - Female G1 union nut connection)
No. 17 701.73 (Male ISO 7/1-R1" - OD28mm connection)
No. 17 701.74 (Male G3/4 - Female G1 union nut connection)

Material: Silicone
 Braiding: Stainless Steel
 Inside diameter: Ø25mm
 Outside diameter: Ø34mm
 Max.working pressure: 10 bar
 Max.working temperature: 90°C

For more information and technical datasheets please contact your BROEN-LAB sales representative.

TEST EQUIPMENT FOR EMERGENCY SHOWERS

Test Trolley for Emergency Showers

No. 17 851.92 - model with integrated pump
No. 17 851.93 - model without pump

Test trolley with or without integrated pump.
 Drainage hose is included. Capacity: 90 l
 Can be used for heated and unheated emergency showers.

Weight: Approx. 22 kg



Test Funnel for Emergency Showers

No. 17 001.08

Test funnel for testing of emergency showers in PC (polycarbonate) with 2.2m hose.

No. 27 99 008 10 01

Measuring Cylinder for checking Eye Wash Stations



EYE WASH BOTTLES

Duo Eye Wash Bottle, 500ml pH Neutral

No. P7 17 003 10 00 000

DUO 500ml pH neutral.

Sterile 4.9 % Phosphate buffer solution.

For neutralizing acids and alkalis.

Complete with an eye device for washing both eyes at the same time.

Durability 3 years.

Full box with 6 units available.

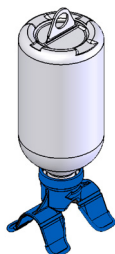

Eye Wash Bottle (single eye), 200ml pH Neutral

No. P7 17 004 10 00 000

200ml pH neutral.

A small, handy bottle containing 4.9% sterile phosphate buffer solution that neutralizes the eye's fluid after accidents involving acids or alkali.

The bottle is provided with an ergonomic eye cup, a dust cap and clear instructions on the label.

Durability 3 years.

Full box with 10 units available.



Duo Eye Wash Bottle, 500ml Sterile Solution

No. P7 17 002 10 00 000

DUO 500ml Sterile.

Bottle containing a 0.9% sterile sodium chloride solution. Complete with an eye device for washing both eyes at the same time.

Durability 3 years.

Full box with 12 units available.

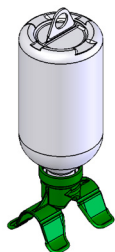

Eye Wash Bottle (single eye), 500ml Sterile Solution

No. P7 17 001 10 00 000

500ml Sterile.

Bottle containing a 0.9% sterile sodium chloride solution.

The bottle is provided with an ergonomic eye cup, a dust cap and clear instructions on the label.

Durability 3 years.

Full box with 12 units available.



Eye Wash Station

No. P7 33 001 10 00 402

Dust-proof wall mounted eye wash station in ABS plastic for two 500ml eye wash bottles + one 200ml eye wash bottle.

Especially suitable for dirty and dusty production areas and mobile work places.

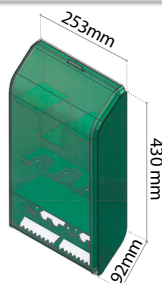

Eye Wash Station (classic model)

No. P7 33 002 10 00 402

Dust-proof wall mounted eye wash station in polystyrene for two 500ml eye wash bottles.

Especially suitable for dirty and dusty production areas and mobile work places.



Wall Mount for Eye Washes (Duo or single eye)

No. P7 53 001 10 00 409

Wall mount for pH neutral solutions (blue)

No. P7 53 001 10 00 402

Wall mount for sterile solutions (green)

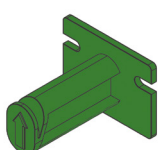

Wall Mount for Eye Washes (single eye)

No. P7 53 002 10 00 409

Wall mount for pH neutral solutions (blue)

No. P7 53 002 10 00 402

Wall mount for sterile solutions (green)

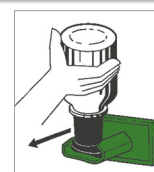
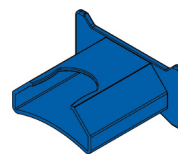

For more information and technical datasheets please contact your BROEN-LAB sales representative.

HAND-HELD EYE SHOWERS - CLASSIC MODELS

Shower for General Purpose without FLOWFIX, Hand-Held

No. 17 701.500
VVS: 765955 345

Weight: Approx. 0.5 kg
Shower for general purpose, hand-held in Polyarylamide, reinforced with glassfibres. Trigger operated without FLOWFIX regulator.

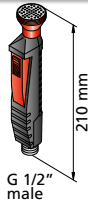

No. 17 701.000
VVS: 765955 315

Weight: Approx. 0.5 kg
Including table mounting accessories



No. 17 711.000
VVS: 765942 315

Weight: Approx. 0.5 kg
Including bracket for wall mounting.

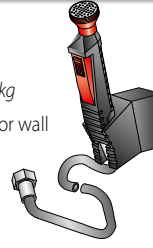

No. 17 731.009
VVS: 766108 305

Weight: Approx. 0.5 kg
Including bracket for modular body showers

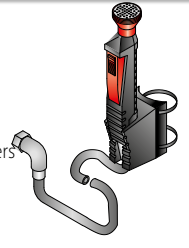

Anti-corrosive

No. 17 741.504
Same as model above but in SS and stanilloy.



Anti-corrosive

No. 17 741.204
Same as model above but in SS and stanilloy.



Anti-corrosive

No. 17 741.104
Same as model above but in SS and stanilloy.



Anti-corrosive

No. 17 741.004 / VVS: 766108 300
Same as model above but in SS and stanilloy.

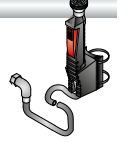

Eye Shower with One Straight Head, Hand-Held

No. 17 702.500
VVS: 765956 345

Weight: Approx. 0.5 kg
hand-held eye shower in Polyarylamide, reinforced with glassfibres. Trigger operated including a built-in FLOWFIX for regulation of water flow (8 l/min).

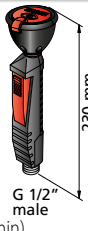

No. 17 702.000
VVS: 765956 315

Weight: Approx. 0.5 kg
Including table mounting accessories

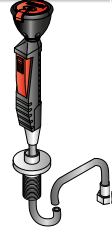

No. 17 712.000
VVS: 765944 315

Weight: Approx. 0.5 kg
Including bracket for wall mounting.

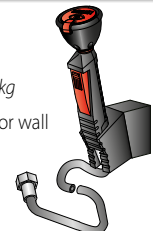

No. 17 732.009
VVS: 766101 305

Weight: Approx. 0.5 kg
Including bracket for modular body showers

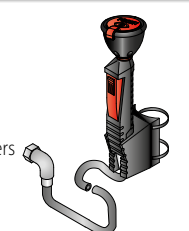

Anti-corrosive

No. 17 742.504
Same as model above but in SS and stanilloy.



Anti-corrosive

No. 17 742.204
Same as model above but in SS and stanilloy.



Anti-corrosive

No. 17 742.104 / VVS: 765944 300
Same as model above but in SS and stanilloy.



Anti-corrosive

No. 17 742.004 / VVS: 766101 300
Same as model above but in SS and stanilloy.

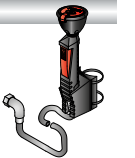

Eye Shower with One Angled Head, Hand-Held

No. 17 713.500
Weight: Approx. 1 kg

Eye shower with one angled head, hand-held. In Polyarylamide, reinforced with glassfibres. Trigger operated including a built-in FLOWFIX for regulation of water flow (8 l/min).



No. 17 717.000
VVS: 765954 315

Weight: Approx. 1 kg
Including table mounting accessories

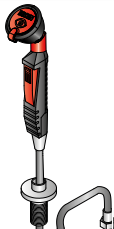

No. 17 713.000
VVS: 765946 315

Weight: Approx. 1 kg
Including bracket for wall mounting.

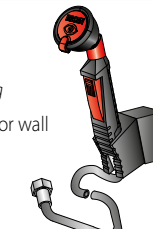

No. 17 733.009
VVS: 766102 305

Weight: Approx. 1 kg
Including bracket for modular body showers



Anti-corrosive

No. 17 743.504
Same as model above but in SS and stanilloy.



Anti-corrosive

No. 17 743.204
Same as model above but in SS and stanilloy.

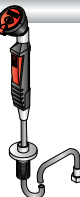

Anti-corrosive

No. 17 743.104
Same as model above but in SS and stanilloy.



Anti-corrosive

No. 17 743.004 / VVS: 766102 300
Same as model above but in SS and stanilloy.

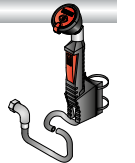

Eye Shower with Two Angled Heads, Hand-Held

No. 17 715.500
Weight: Approx. 1.5 kg

Eye shower with two angled heads, hand-held. In Polyarylamide, reinforced with glassfibres. Trigger operated with BALLOFIX* included for regulation of water. Min. inlet pressure, dynamic: 1.5 bar / 22 psi flow.

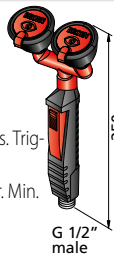

No. 17 714.000
VVS: 765957 315

Weight: Approx. 1.5 kg
Including table mounting accessories

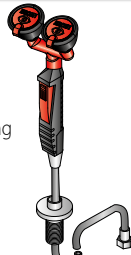

No. 17 715.000
VVS: 765908 315

Weight: Approx. 1.5 kg
Including bracket for wall mounting.

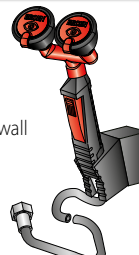

No. 17 734.009
VVS: 766103 305

Weight: Approx. 1.5 kg
Including bracket for modular body showers

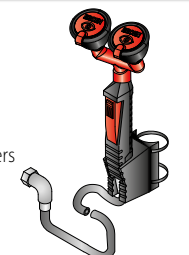

Anti-corrosive

No. 17 744.504
Same as model above but in SS and stanilloy.



Anti-corrosive

No. 17 744.204
Same as model above but in SS and stanilloy.

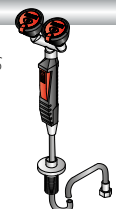

Anti-corrosive

No. 17 744.104
Same as model above but in SS and stanilloy.



Anti-corrosive

No. 17 744.004 / VVS: 766103 300
Same as model above but in SS and stanilloy.

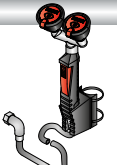

Min. working pressure: 1.5 bar for all Eye Showers on this page.

INTRODUCTION

Thousands of industrial accidents happen every year in spite of precautionary safety measures, accidents that are caused by human exposure to heat (fire, boiling water and oil, steam, etc.), to corrosive agents (fluid acids and caustics) and/or to influence by dust and corrosive aerosols (metal, dirt, fluids).



These accidents cause the injured person acute pain, disablement and may even lead to loss of life. However, experience shows that the consequences and human suffering following such accidents can be considerably limited if water is applied directly to the affected areas instantly after the exposure.

It is a fact of life that the risk lurks in many places: in the laboratory, in the kitchen, in the warehouse, in the chemical plant, in the workshop or generally speaking in any place where heat, corrosion or dust can cause serious human injury. For these reasons we strongly recommend the installation of adequate emergency shower systems as a means of limiting these risks.

Location and Operation of Emergency Showers

As a basic rule the shower must be located as close to the workplace as possible so that the general first aid instructions of flushing the affected area immediately after the accident has occurred can be followed.

Please note that if strong acids or caustics are involved immediate action is demanded. When installing the emergency shower system please also be aware that it must be easy to locate and access at all times for potential users.

BROEN-LAB Emergency Showers can be recognized by their red and white stripes on body and eye showers, red pull rods and luminescent signs and symbols for the clear identification of emergency shower.

Mobile and portable emergency showers - see page 20



Heated body showers - see page 18-19

Selecting the Right Shower

There are many different conditions that determine the type of emergency shower to be installed. It is important that the chosen unit is designed and tested according to the existing standard as well as suits the specific application and location - **and environment!**



Tank showers - see page 21

In this section you can find a wide range of BROEN-LAB Emergency Showers that can be installed outside and be used in areas where outside temperatures go as low as -35°C.



HEATED COMBINATION SHOWERS

Frost protected outdoor combination safety showers, trace tape heated and pre-insulated. Delivered with eye/facewash fountain and additional eyebath diffuser on flexible hose to treat unconscious or disabled personnel.

Available in Galvanized or Stainless Steel.

Heated Body Shower - Free Standing with Eye Wash Fountain

Heated Body Shower - Free Standing with Eye Wash Fountain

-20°C

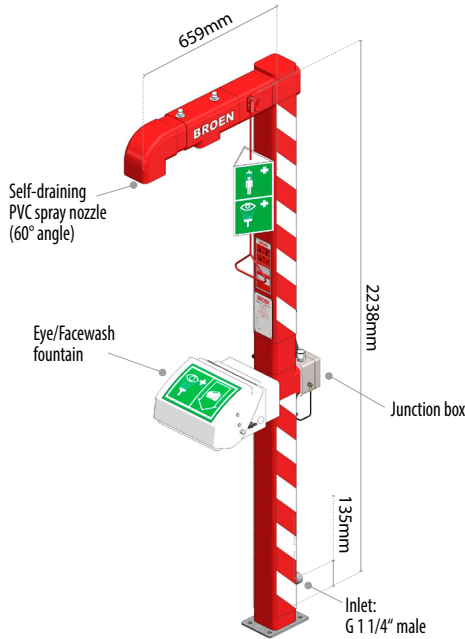

-35°C

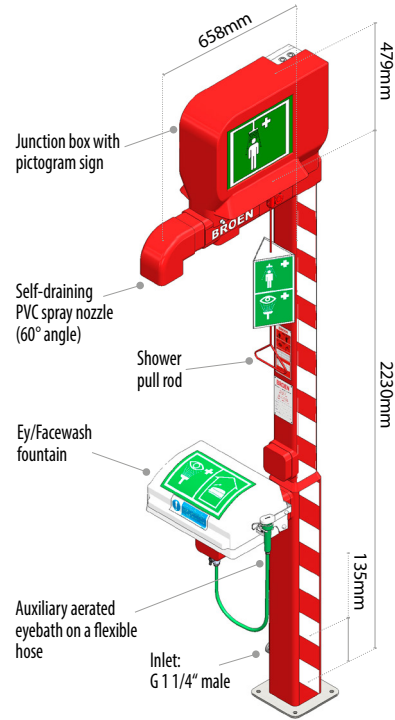

BROEN-LAB EMERGENCY SHOWER SYSTEMS

TECHNICAL SPECIFICATIONS

Min. working pressure: 2 Bar
Min. working temperature: -20°C
Water Flow: 115 l/min.
Supply voltage: 230 VAC, 50/60 Hz

Heated underground extension pipe (ordered separately, see page 22 for more information)



TECHNICAL SPECIFICATIONS

Min. working pressure: 2 Bar
Min. working temperature: -35°C
Water Flow: 115 l/min.
Supply voltage: 230VAC, 50/60Hz

Heated underground extension pipe (ordered separately, see page 22 for more information)

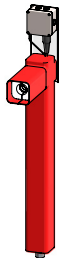

ORDERING INFORMATION

BROEN-LAB item no.	Material	Ex-proof*	Min. working temperature	Eye wash fountain	Mounting	Heated underground extension pipe
H7 41 002 10 00 321	Galvanized Steel	Yes	-20°C	Yes	Floor	Available
H7 41 002 10 00 221	Stainless Steel	Yes	-20°C	Yes	Floor	Available
H7 41 001 10 00 341	Galvanized Steel	Yes	-35°C	Yes	Floor	Available
H7 41 001 10 00 241	Stainless Steel	Yes	-35°C	Yes	Floor	Available
H7 41 001 10 00 331	Galvanized Steel	No	-35°C	Yes	Floor	Available
H7 41 001 10 00 231	Stainless Steel	No	-35°C	Yes	Floor	Available

*Ex-proof zone 1 and zone 2.

For more information and technical datasheets please contact your BROEN-LAB sales representative.

HEATED BODY SHOWERS

Frost protected outdoor combination safety showers, trace tape heated and pre-insulated.
Available in Galvanized or Stainless Steel.

Heated Body Shower - Free Standing

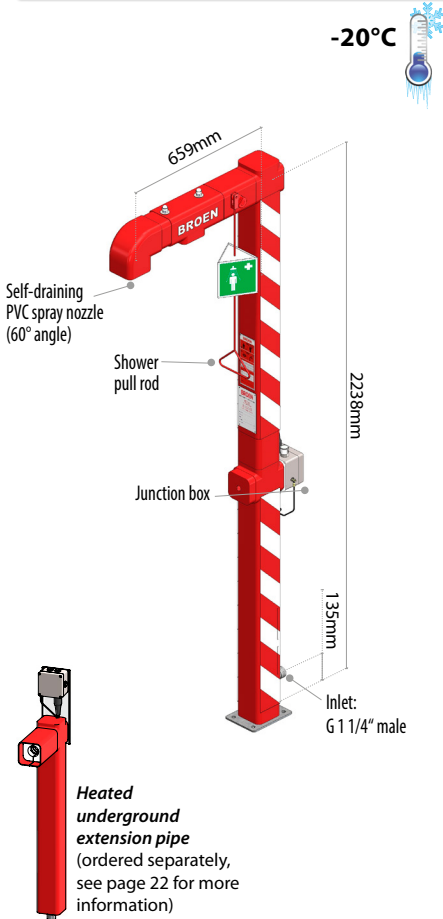

Heated Body Shower - Free Standing

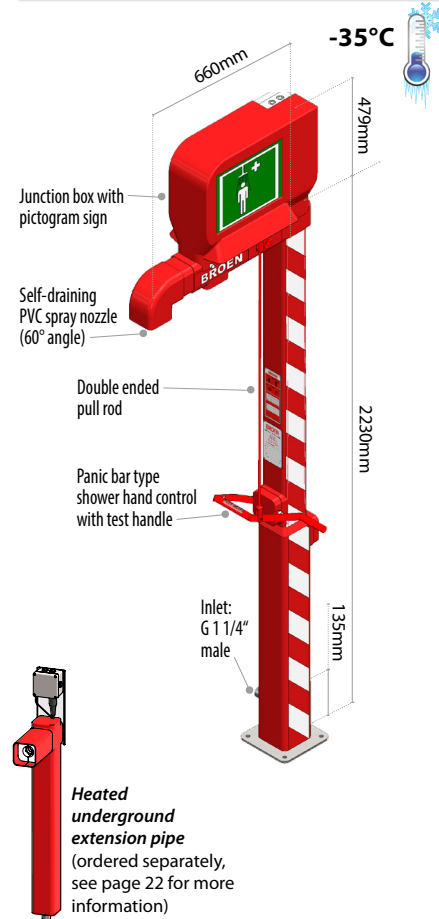

Heated Body Shower - Wall Mounted

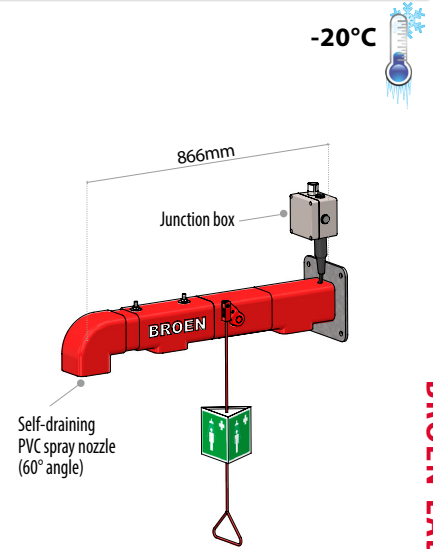

TECHNICAL SPECIFICATIONS

Min. working pressure: 2 Bar
Min. working temperature: -20°C
Water Flow: 115 l/min.
Supply voltage: 230VAC, 50/60Hz

TECHNICAL SPECIFICATIONS

Min. working pressure: 2 Bar
Min. working temperature: -35°C
Water Flow: 115 l/min.
Supply voltage: 230VAC, 50/60Hz

TECHNICAL SPECIFICATIONS

Min. working pressure: 2 Bar
Min. working temperature: -20°C
Water Flow: 115 l/min.
Supply voltage: 230VAC, 50/60Hz

ORDERING INFORMATION

BROEN-LAB item no.	Material	Ex-proof*	Min. working temperature	Eye wash fountain	Mounting	Heated underground extension pipe
H7 21 002 10 00 321	Galvanized Steel	Yes	-20°C	No	Floor	Available
H7 21 002 10 00 221	Stainless Steel	Yes	-20°C	No	Floor	Available
H7 21 001 10 00 341	Galvanized Steel	Yes	-35°C	No	Floor	Available
H7 21 001 10 00 241	Stainless Steel	Yes	-35°C	No	Floor	Available
H7 21 001 10 00 331	Galvanized Steel	No	-35°C	No	Floor	Available
H7 21 001 10 00 231	Stainless Steel	No	-35°C	No	Floor	Available
H7 23 001 10 00 321	Galvanized Steel	Yes	-20°C	-	Wall	-
H7 23 001 10 00 221	Stainless Steel	Yes	-20°C	-	Wall	-

*Ex-proof zone 1 and zone 2.

For more information and technical datasheets please contact your BROEN-LAB sales representative.

HEATED EYE SHOWERS

Heated Eye Wash Fountain, Pedestal Mounted

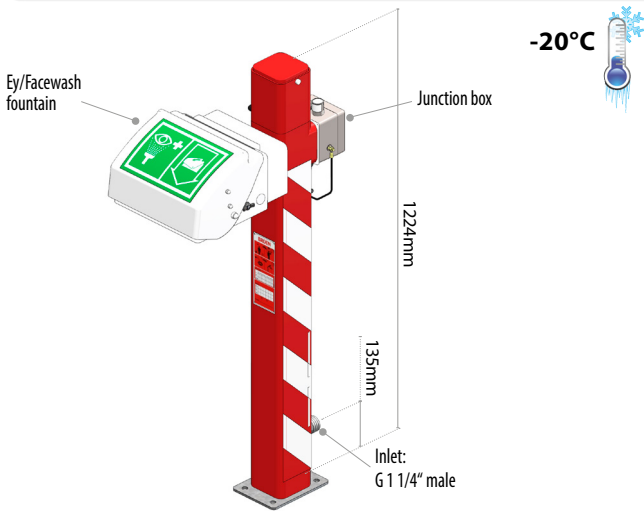

Outdoor pedestal mounted emergency eye/facewash fountain, trace tape heated and pre-insulated. Delivered with “unbreakable” integral lid, aerated diffusers, flow regulator and self-adhesive sign.

Available in Galvanized or Stainless Steel.

TECHNICAL SPECIFICATIONS

Min. working pressure: 2 Bar
 Min. working temperature: -20°C
 Water Flow: 20 l/min.
 Supply voltage: 230VAC, 50/60Hz

Heated underground extension pipe (ordered separately, see page 22 for more information)

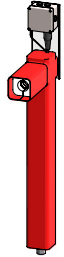

ORDERING INFORMATION

BROEN-LAB item no.	Material	Ex-proof*	Min. working temperature	Mounting	Heated underground extension pipe
H7 31 001 10 00 321	Galvanized Steel	Yes	-20°C	Floor	Available
H7 31 001 10 00 221	Stainless Steel	Yes	-20°C	Floor	Available

*Ex-proof zone 1 and zone 2.

MOBILE & PORTABLE EMERGENCY SHOWERS

Mobile Emergency Safety Shower is designed as a quick response, first-aid device for use where a plumbed-in unit is not available and must therefore be backed up by a method of further decontamination.

Mobile Self Contained Emergency Safety Shower

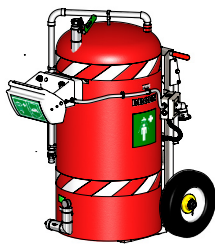

TECHNICAL SPECIFICATIONS

Capacity: 114 l
 Min. working temperature: -10°C
 Water Flow: 40 l/min.
 Supply voltage: 230VAC, 50/60Hz

ORDERING INFORMATION

BROEN-LAB item no.	Material	Ex-proof*	Min. working temperature
H7 47 002 10 00 311	Galvanized & SS	No	-10°C
H7 47 002 10 00 321	Galvanized & SS	Yes	-10°C
H7 47 002 10 00 301	Galvanized & SS	No	+1°C (unheated)

*Ex-proof zone 1 and zone 2.

Portable Emergency Eye, Face and Body Shower (Unheated)



No. H7170011000303

TECHNICAL SPECIFICATIONS

Capacity: 15 l
 Min. working temperature: +1°C
 Water Flow: 8 l/min.
 Material: Stainless Steel cylinder

Mobile Self Contained 1200 L Shower and Eyewash incl. Pump

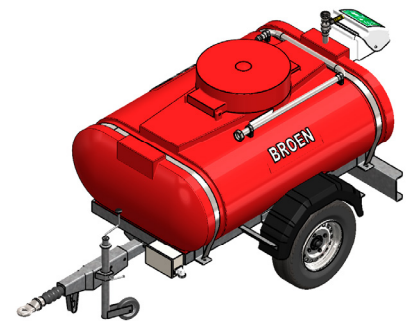

No. H7470031000331

TECHNICAL SPECIFICATIONS

Capacity: 1200 l
 Min. working temperature: -10°C
 Water Flow: 75 l/min.
 Supply voltage: 230VAC, 50/60Hz
 Material:
 - Galvanized mild steel trailer
 - Red polyethylene tank

HEATED TANK SHOWERS

A range of heavy duty emergency tank showers, for use when warm water is required, or a constant supply of water cannot be guaranteed.

These units are essential where there is a problem with insufficient water pressure or inadequate flow rate. This improved range incorporates models to suit a wide range of situations.

Body Shower with Eye Wash Fountain & 350 l tank



Body Shower with Eye Wash Fountain & 1200 l tank

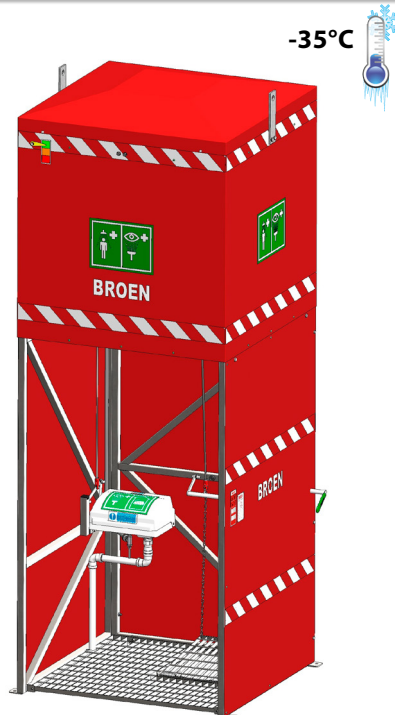

Standard Configuration

- 350 or 1200 l tank in medium density polythene
- Support legs and frame in galvanized or Stainless Steel
- Rear and side GRP panelling
- Visual level indicator
- Body shower
- Eye/facewash fountain
- Shower control panic bar
- Foot panel for body shower

TECHNICAL SPECIFICATIONS

Min. working temperature: -35°C
 Water Flow: 75 l/min.
 Supply voltage: 230VAC, 50/60Hz

*750l tank shower is available on request

Tank showers are available in three sizes:

The **350 liter** model supplies a guaranteed flow of warm water for several minutes.

With the mains supply permanently connected, the **750* liter** model will deliver warm water for 15 minutes, recommended by ANSI Z 358.1 and EN15154-1&2 standards.

The **1200 liter** models will meet the mentioned standards even without an external supply connected.

Available in Galvanized or Stainless Steel.

For areas with high outside temperatures models with chillers can be supplied.

Unheated models are also available.

BROEN-LAB EMERGENCY SHOWER SYSTEMS

ORDERING INFORMATION

BROEN-LAB item no.	Material	 Ex-proof*	Min. working temperature	Eye wash fountain	Tank volume
H7 61 001 10 01 341	Galvanized Steel	Yes	-35°C	Yes	350 l
H7 61 001 10 01 241	Stainless Steel	Yes	-35°C	Yes	350 l
H7 61 001 10 01 331	Galvanized Steel	No	-35°C	Yes	350 l
H7 61 001 10 01 231	Stainless Steel	No	-35°C	Yes	350 l
H7 61 003 10 01 341	Galvanized Steel	Yes	-35°C	Yes	1200 l
H7 61 003 10 01 241	Stainless Steel	Yes	-35°C	Yes	1200 l
H7 61 003 10 01 331	Galvanized Steel	No	-35°C	Yes	1200 l
H7 61 003 10 01 231	Stainless Steel	No	-35°C	Yes	1200 l

*Ex-proof zone 1 and zone 2.

For more information and technical datasheets please contact your BROEN-LAB sales representative.

ACCESSORIES FOR HEATED SHOWERS

Heated Underground Extension Pipe for Heated Body Showers

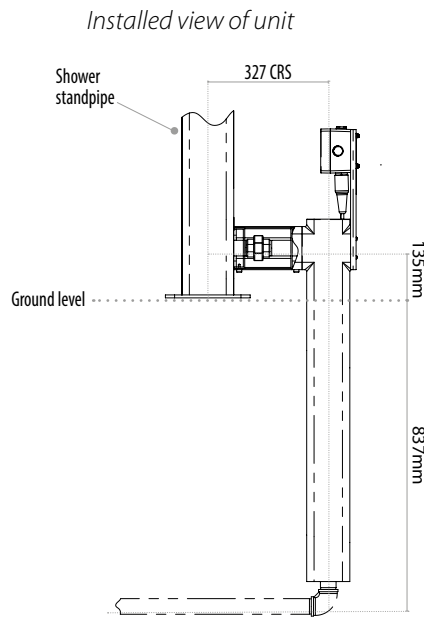

Heated underground extension pipe, trace tape heated and pre-insulated. To be used for connecting to an underground supply. Available in Galvanized or Stainless Steel.

TECHNICAL SPECIFICATIONS

Min. working temperature: -35°C
Supply voltage: 230VAC, 50/60Hz

ORDERING INFORMATION

BROEN-LAB item no.	Material	 Ex-proof*	Min. working temperature	Mounting
H7 51 001 10 00 321	Galvanized Steel	Yes	-35°C	Underground
H7 51 001 10 00 221	Stainless Steel	Yes	-35°C	Underground

*Ex-proof zone 1 and zone 2.

BROEN-LAB EMERGENCY SHOWER SYSTEMS

Foot Panel for Operation of Heated Eye Wash

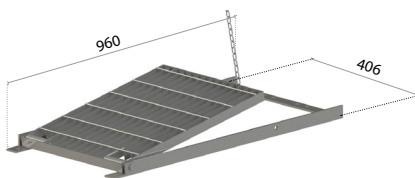

Weight: Approx. 23 kg

No. 17 803.009 (VVS: 766198 803) - Stainless Steel version

No. 17 833.009 - Galvanized Steel version

Foot panel or treadle for operation of **heated body shower** is also available - contact your BROEN-LAB sales representative for further information.

Foot Treadle for Operation of Heated Eye Wash



No. 17 804.009 (VVS: 766198 804) - Stainless Steel version

For heated eye washes operational down to -20°C

No. 17 805.009 - Stainless Steel version

For heated eye washes operational down to -35°C

For more information and technical datasheets please contact your BROEN-LAB sales representative.

Emergency Showers Are Important

Thousands of industrial accidents happen every year in spite of precautionary safety measures, accidents that are caused by human exposure to heat (fire, boiling water and oil, steam, etc.), to corrosive agents (fluid acids and caustics) and/or to influence by dust and corrosive aerosols (metal, dirt, fluids).

These accidents cause the injured person acute pain, disablement and may even lead to loss of life.

However, experience shows that the consequences and human suffering following such accidents can be considerably limited if water is applied directly to the affected areas instantly after the exposure.

It is a fact of life that the risk lurks in many places: in the laboratory, in the kitchen, in the warehouse, in the chemical plant, in the workshop or generally speaking in any place where heat, corrosion or dust can cause serious human injury.

For these reasons we strongly recommend the installation of adequate emergency shower systems as a means of limiting these risks.

Location and Operation of Emergency Showers

As a basic rule the shower must be located as close to the workplace as possible so that the general first aid instructions of flushing the affected area immediately after the accident has occurred can be followed.

Please note that if strong acids or caustics are involved immediate action is demanded.

When installing the emergency shower system please also be aware that it must be easy to locate and access at all times for potential users.

The BROEN-LAB showers can be recognized by their red body shower pull rods and red eye shower push handles. In addition the internationally adapted graphic symbols for the clear identification of emergency shower installations are always included in BROEN-LAB solutions.

Further information and guidelines can be found in the EN 15154 part 1 & 2: 2006 - European standard for Emergency safety showers

Operation

All BROEN-LAB emergency shower systems are designed and engineered to secure easy operation. This allows for "one-action" activation of the shower system ensuring immediate and continued flushing without any need for further action.

This easy operation also allows the injured person to use both hands to keep his eyes open for effective flushing, to undress under the shower or just to help exposing the affected area for better and more expedient treatment.

On the eye shower the nozzles are protected by rubber cups to keep the injured person from hurting himself unintentionally. The nozzles are also protected against dust and dirt by the caps which are removed automatically by the initial jet of water.

Water Pressure and Temperature

Emergency showers shall be connected to a cold water system with at least drinking water quality which ensures clean and fresh water. In addition we recommend the water temperature to be kept within the range of 15° to 25° Celsius in order to provide the best immediate effect, reasonable human comfort and at the same time avoid hypothermia.

All eye showers are delivered with FLOWFIX water regulating devices ensuring constant adequate water flow regardless of high water pressure.

The illustrations will inform you of the capacities of the showers.

Threading

In general the BROEN-LAB Emergency Showers are equipped with threadings as follows:

E.g. G 1/2": In accordance to ISO 228/1.

E.g. NPT 1/2": In accordance to ANSI-B1.20.1.

Maintenance and Information

When installing emergency shower systems, the relevant safety advisor must provide instructions on operation and maintenance!

As basic information the potential user must be advised of:

- The location of the emergency shower system
- How to operate it and
- How to behave in case of an emergency

BROEN-LAB recommends users to check installed emergency shower systems once a week.

IN CASE OF AN EMERGENCY

In the event of accidents caused by human exposure to heat, corrosive agents and/or to influence of dust and corrosive aerosols:

- ☞ Start flushing immediately – the seconds count.
- ☞ Remove contaminated clothing which is not stuck to the skin.
- ☞ Continue flushing.
- ☞ In case of an eye injury keep the eyelid open when continuing flushing.
- ☞ Call for an ambulance. Ask the doctor for advice.
- ☞ Continue flushing in the ambulance.
- ☞ Keep the flushing in the emergency room and during transport to the special ward.

In case of blistering do inform the doctor and the hospital about the substance in question and about possible countermeasures.

RAPID ACTION CAN BE OF VITAL IMPORTANCE.

PERSONAL WASH UNIT

The first seconds following an eye injury are often critical to keeping eye injury to a minimum. A personal wash unit may be kept in the immediate vicinity of employees working in a potentially hazardous area.

The main purpose of these units is to supply immediate flushing. With this accomplished, the injured individual should then proceed to a plumbed or self-contained eyewash and flush the eyes for the required 15-minute period.

REFERENCE: A1 PERSONAL WASH UNIT, ANSI Z358.1-2014

INTERNATIONAL STANDARDS
EN-NORM 15154-1&2
 (European Committee for Standardization)

MAIN REQUIREMENTS

- The water supplied by the body shower shall be of constant flow rate in accordance with national regulations at a flow pressure to be specified by the manufacturer. The flow pressure shall be specified and measured where the shower is connected to the water system. The body shower shall be capable of delivering this supply for a minimum of 15 minutes. Note: When no national or local regulations apply, a constant flow rate of min. 60 l/min is suitable.
- It shall only be possible to make adjustments with a tool to the direction of spray or the water distribution of a shower head. The shower head shall be self-draining between the valve and the outlet. The shower head shall be removable for maintenance but only by use of a tool.
- At a distance 700 mm below the shower head, 50% (+/-10%) of the volume of water delivered shall fall in a circle with a radius of 200mm; the water level in the individual compartments in this circle shall not deviate by more than 30% from the mean value. At this measuring level, the area reached by minimum 95% of the water shall be limited to a circle with a radius of 400 mm. The velocity of the water spray shall be low enough to be non-injurious to the user.
- The shower head shall be designed to be installed so that its lower edge is (2200 +/- 100) mm above the level on which the user stands.
- The valve shall not close automatically once it has been opened. The direction of operating the valve actuator shall be clearly visible and unmistakable.

BROEN-LAB EMERGENCY SHOWER SYSTEMS

OPEN SPACE

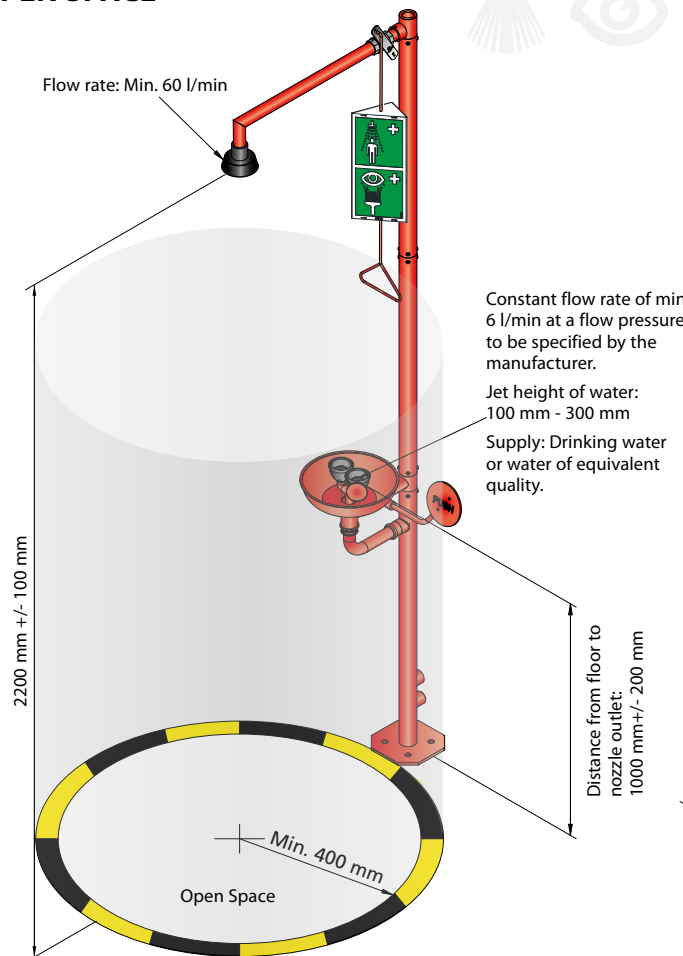

WATER PATTERN

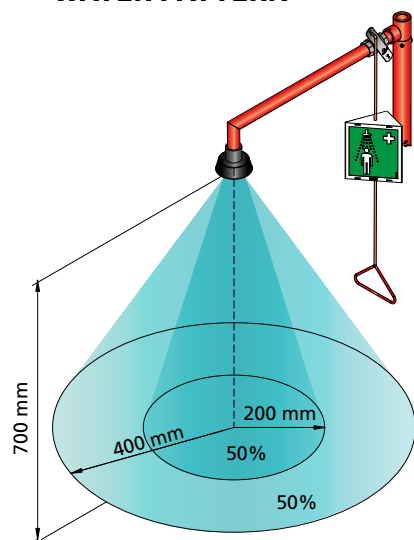

TYPE TESTING OF WATER DISTRIBUTION

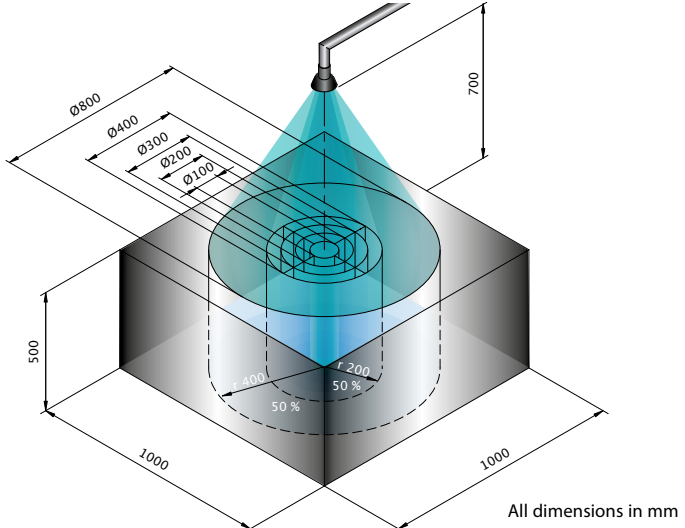

Please refer to www.BROEN-LAB.com for a 3rd party certificate for EN 15154

INTERNATIONAL STANDARDS
ANSI NORM Z 358.1-2014
(American National Standard Institute)

MAIN REQUIREMENTS

- Emergency eyewash and showers must be located in such a way that they can be reached by the user within maximum 10 seconds and available for immediate use (ref.: 4.5.2 + Safety considerations - B5).
- Eye/face showers must be able to deliver at least 11.4 l. water per minute continuously for at least 15 minutes (ref.: 6.1.6).
- The handle of pull rod must be located at a maximum height of 173.3 cm above the floor (ref.: 4.2).
- The valve must go from “off” to “on” position within 1 second or less and be able to remain open without further action. (ref.: 4.2).
- The body shower must be capable of delivering flushing fluid at a minimum of 75.7 liters per minute continuously for a minimum of 15 minutes (ref.: 4.1.4).

- The diameter of the water spray pattern must be minimum 50.8 cm measured at 152.4 cm above the floor (ref.: 4.1.4).
- The face of the showerhead shall be located within a range of 208.3 cm to 243.8 cm from the floor (ref.: 4.4.1).
- The eye/face showers flushing fluid flow pattern must be located within a range of 83.8 cm to 134.6 cm above the floor (ref.: 5.4.4).
- The shower must be activated at least once a week (ref.: 4.6.2).
- Tepid water is required in all showers (ref.: 4.5.6 + Safety considerations - B5).

Reference: ANSI Z 358.1-2014

OPEN SPACE

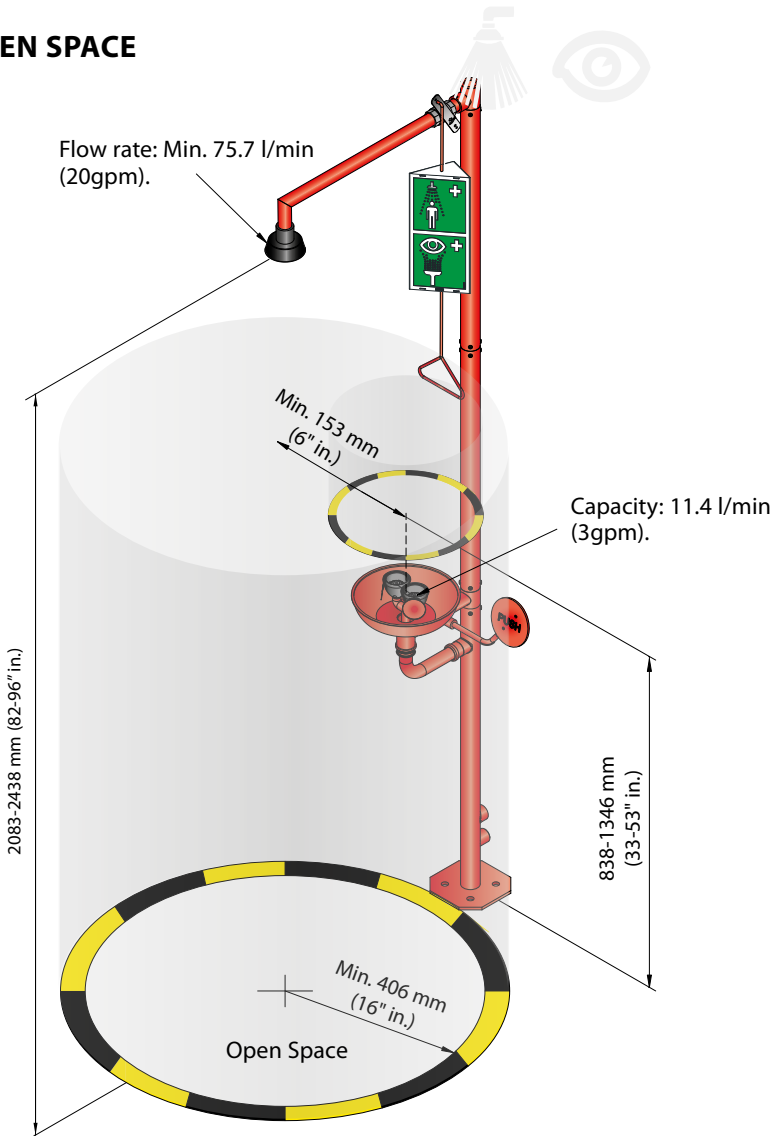

An eye shower is the only allowable exception from the rule that no obstructions are allowed in the “open space”.

WATER PATTERN

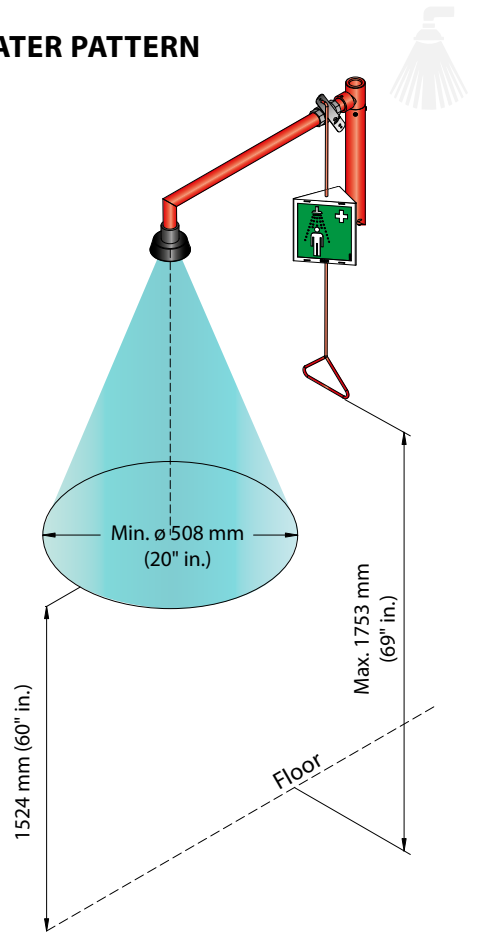

SPECIFICATION OF MATERIALS

Shower outlet	Brass/PP or PPO
Stand pipe	Stainless steel (AISI 304) or brass
Rubber cups	EPDM
Dust caps	POM
Bowl	Stainless steel (AISI 304)

Available in chemical resistant "BROEN-LAB Polycoat" (polyester powder coating) or "Stanniloy" plating (a highly anti-corrosive treatment based on a tin/nickel alloy).

MIN. WORKING PRESSURE (DYNAMIC/FLOW PRESSURE)

See individual products.

MAX. WORKING PRESSURE (STATIC)

kPa	kN/m ²	bar	psi
1000	1000	10	145

FLOWFIX

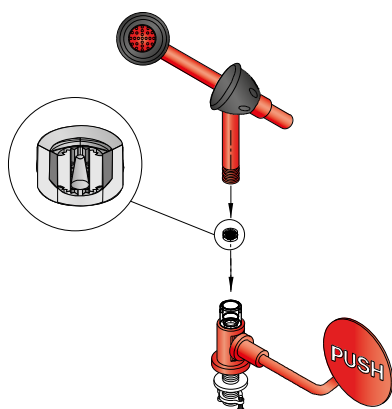

FLOWFIX is a feature that is built into most of BROEN-LAB's eye baths and hand/eye showers. Flowfix is a water regulating device, that controls the water flow at a preset rate regardless of water pressure.

SYMBOLS:



Eye shower



Body shower



For disabled people as well

SELF-DRAINING SHOWER HEAD

BROEN-LAB has developed a new self-draining emergency shower head in compliance with both EN15154-1 and ANSI Z358.1-2014.

BROEN-LAB has 3rd party certificate for EN 15154 and ANSI Z358.1-2014. The self-draining shower head requires min. 1 bar (14.5 psi) and max. 10 bar (145 psi) dynamic water pressure for optimal function.

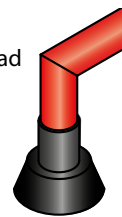

FEATURES & BENEFITS

- ✓ Self-draining, anti lime scale - prevents bacteria build-up and reduces maintenance
- ✓ Complies to both EN & ANSI Standards
- ✓ Chemical resistant PPO plastics
- ✓ Soft water spread
- ✓ Available for 1/2", 3/4" and 1" pipes

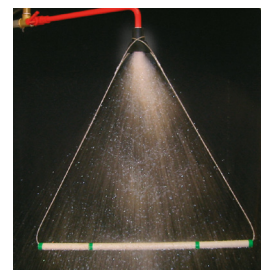

CALCULATING THE FLOWRATE AND DYNAMIC PRESSURE DROP

Any calculation can be done using the following formulas:

$$K_v = \frac{q_v [\text{m}^3/\text{h}]}{\sqrt{\Delta P [\text{bar}]}} \quad \text{or} \quad q_v = K_v \times \sqrt{\Delta P} \quad \text{or} \quad \Delta P = \left(\frac{q_v}{K_v} \right)^2$$

Where

K_v = flowrate [m³/h] or [l/sec] at 1 bar pressure drop

q_v = flowrate [m³/h] or [l/sec]

ΔP = pressure drop [bar]

1) Please note that eye showers with built-in FLOWFIX have a fixed flowrate.

Examples:

What pressure drop is needed in order to achieve 75 l/min = 1.25 l/sec through a body shower with 1/2" inlet?

$$\Delta P = \left(\frac{q_v}{K_v} \right)^2 = \left(\frac{1.25 [\text{l/sec}]}{1.08 [\text{l/sec}]} \right)^2 = 1.34 [\text{bar}]$$

What flowrate can be expected through a free standing body shower with top inlet at a pressure drop of 1.5 bar?

$$q_v = K_v \times \sqrt{\Delta P} = 1.10 [\text{l/sec}] \times \sqrt{1.5 [\text{bar}]} = 1.35 \text{ l/sec} = 80.8 \text{ l/min.}$$

K_v VALUES

Type of shower	Eye shower without FLOWFIX ¹⁾	Body shower 1/2" pipe or inlet	Body shower 3/4" pipe or inlet	Body shower 1" pipe or inlet	Free standing-body shower, top inlet	Free standing-body shower, bottom inlet	Thermostatic mixing valve 17 140.009	Thermostatic mixing valve 17 459.009
K _v -value	m ³ /h	0.75	3.89	4.3	5.31	3.97	2.99	1.25
	l/sec	0.21	1.08	1.19	1.48	1.10	0.83	1.44

NOTES

BROEN-LAB develops, manufactures and sells Laboratory Fittings, Emergency Shower Systems and Eye Wash Systems into a broad spectrum of laboratories and industrial locations; sectors include Pharmaceutical, Food&Beverage and Academia. Our expertise and product quality ensure optimal solutions compliant to all relevant international norms setting new standards in risk mitigation in modern research and development facilities.

BROEN-LAB offer solutions that ensure the functionality, compliance, hygiene, durability and safety are of the highest priority. For over 50 years our products have been integrated into a wide variety of workplaces, laboratories, hospitals and industrial locations, with features that are assessed and designed to be flexible, durable and compliant offering a broad range of options tailored to each location. This inherent design integrity provides confidence in the solution adopted wherever in the world these are applied.

BROEN-LAB is a collaboration partner in the design and layout of your next laboratory and it's integrated safety solutions.

HEAD OFFICE

BROEN-LAB A/S

Drejervænget 2 • DK-5610 Assens
Tel. +45 6376 6376 • Fax +45 6471 2476
E-mail: lab@broen-lab.com



BROEN-LAB A/S ISO 9001 certification

In September 1991 BROEN-LAB A/S was certified according to ISO 9001 as one of the first Danish companies. The certification was carried out by Bureau Veritas, Denmark, for our Danish site in Assens. The quality management system of BROEN-LAB A/S now complies with detailed specifications laid down by the internationally acknowledged EN ISO 9001:2008. This certification will further contribute to reputation for quality and reliability of BROEN-LAB A/S.

INTERNATIONAL OFFICES

BROEN-LAB Ltd.

Unit 9 Navigation Point, Golds Hill Way
Tipton • West Midlands DY4 0PY • U.K.
Tel. +44 121 522 4515 • Fax +44 121 522 4535
E-mail: lab@broen-lab.com

BROEN-LAB Singapore Pte. Ltd.

10 Bukit Batok Crescent #10-02 • The Spire • Singapore 658079
Tel: +65 6298 0662 • Fax: +65 6298 0468
E-mail: lab@broen-lab.com

BROEN-LAB GmbH

Tel. +45 6376 6376 • Fax +45 6471 2476
E-mail: lab@broen-lab.com

BROEN-LAB Sverige AB

Tel. +45 6376 6376 • Fax +45 6471 2476
E-mail: lab@broen-lab.com

www.BROEN-LAB.com

BROEN-LAB